

Please read this manual carefully before using and keep these instructions.



TMK MANUAL

Thank you for your selecting Digital Water Bath TMK Series.

- For your safety & life span of the product, please read the manual fully before using and keep these instructions.







CONTACT INFORMATION

Corporate Headquarters:
AS ONE Corporation International Group
2-1-27, Edobori, Nishi-ku
Osaka 550-8527
Japan
Tel: 81-6-6447 8631
Fax: 81-6-6447 8681
E-mail: intl-sales@so.as-1.co.jp

Caution for safety





Please keep these instructions before using and use the product properly.
The below suggestions have possible to connect the serious result.
Please keep these instructions for the safety.

●Warning mark & meaning

 Danger	Danger of death or serious injury is near at hand with wrong handling.
 Warning	Riskiness of death or serious injury may occur with wrong handling.
 Caution	Injury and physical loss only may occur with wrong handling.
 Suggestion	Caution is required for safety.

And please keep these instructions before using and use the product properly.
The below suggestions have possible to connect the serious result.

●Indication mark of safety

	This indicates the general notice, warning, forbidden items.		This indicates the prohibition the case can cause the electric shock with disassemble or reorganization the product
	This indicates the handling instruction for general user.		This indicates the connection of the line, in case of the terminal block machine.

WARRANTY CARD

Product Name & Description :		Date of Purchase : (dd/mm/yyyy)	
Model No :		Serial No :	
Name of Organization or Institution : User's Name:			
Address :			
Tel/Fax :		E-mail Address :	
Dealer's(company) name : Staff :			
Tel/Fax :		E-mail Address :	

(You can fax or mail to the above information. Please keep the original copy and produce it when necessary)

< Warranty >

As One Corporation supply this equipment with a 1-year warranty against manufacturing defects from date of purchase. This warranty is valid only if the unit has been used in accordance with the instructions in this manual and for its intended purpose. As One Corporation shall not be responsible for consequential damages, or damages resulting from the abuse or misuse of this equipment. As One Corporation's liability shall be limited to the repair or replacement of the unit or refund of the purchase price at As One's discretion. If repair or adjustment is necessary and has not been the result of abuse or misuse within the warranty period, please return, freight prepaid, and correction will be made without charge. Out of warranty items will be repaired on a charge basis.

< Exclusions To Warranty >

The warranty shall not apply and not limited to defects resulting from :

- Improper or inadequate maintenance by customer;
- Repair made to product by a person other than As One Corporation or its duly authorized service representative;
- Use of replacement parts that are obtained from a party who is not an authorized dealer of As One Corporation.
- Misuse(including use inconsistent with written operating instructions for the product), mishandling, contamination, overheating, unauthorized modification or alteration of the product by any customer or third party;
- Operation outside of the environmental specifications of the products;
- Connecting or used together with other defective product(s) and/or equipment;
Inadequate voltage, environmental pollution, natural disaster such as fire, lightning, earthquake, tsunami, and other acts of God;
- Inaccurate or insufficient information on warranty card or loss of warranty card.

In no event shall As One Corporation be liable to any party for any direct, indirect, special, incidental, or consequential damages, or for any damages resulting from loss of use or profits, anticipated or otherwise, arising out of or in connection with the sale, use or performance of any products, whether such claim is based on contract, tort(including negligence), any theory of strict liability or regulatory action.

⚠ About the maintenance

Please unplug first for maintenance and repair.

● Usual maintenance

- Please make sure the temperature is lowered enough and populate because the heater is in high temperature right after the stopping of operation.
- Please keep the clean water in a bath. (When liquids with a bad quality or alien substance is mixed are used, it may cause the deterioration or breakdown because dirty or solute is built on the machine.)
- Please wipe alien substances or fur on a heater part, a temperature sensor and keep the product in a clean status.
- Please clean the alien substance or dirt of the inner part of the pump(TMK-1K, TMK-2K, TMK-3K).
- Please clean the alien material or dirt on the switch(Except TMK-1K) and check Flost works smoothly.
- Please clean the alien material on the body with soft and dry towel.
- If it is hard to remove the alien material, please clean the dirty part with small amount of neutral detergent.
- Please do not use solvents such as acids, benzene, cleaner and boiling water. (It may cause discoloration and damage on the surface. And it may cause the discoloration and deterioration of rubber or plastic parts.)
- Please clean with the dry towel if the neutral detergent is used.
- Please keep the product in a dry state.
- Please do not pour water into the control part. (It may cause damage if water is poured into the controller panel part.)
- Please clean the product carefully otherwise it may cause the malfunction.
- Please unplug the power plug from the outlet in case the product is not used for a long time, wrap and keep it in a dry place.

Warning

Do not disassemble, repair or modify the product.
 ※It may cause an electric shock, fire and injury because of the malfunction. 

⚠ After sales service

Request of the repair

Please read Trouble shooting(24, 25 page) carefully and check the product again. When the product still has a problem, stop the operation and unplug it, inquire to the purchasing place.

The specification and dimensions can be changed without previous notice in order to improve the product.

⚠ Caution of using

Caution

Please use the product safely and read the following well before using.
 Please keep the manual near at hand and deliver the product together with this manual always.



- *This water bath is for indoor, please do not use in other places.
- *This water bath is for an experiment. Please do not use in a driving without a person and in an assembly line.



Warning

If the product is handled wrongly, it reduce the life span, also may cause the malfunction and injury, please keep the below suggestions.

- Please use it at the rated power supply. When it used in environment with different rated power supply, it may cause the malfunction or accident.
- Please do not process a power code, change it excessively or put heavy things on it.
- The ambient temperature is +5 ~ +35°C. Please do not operate in beyond of the range.
- The ambient humidity is 35 ~ 85% RH. Please use it in a non-dew status.
- Please use it in the place where is no corrosive or flammable gas etc.
- Please do not use the product in the place where is nearby water because inner part of the body includes electronic accessories and do not pour water into the body.
- Please do not handle the product with a wet hand.
- In case, the body is dropped and broken, please turn off the power switch instantly, unplug the power plug from the outlet and request a repair to the purchasing place.
- When there is a strange sound, smell or smoke, please turn off the power switch instantly, unplug the power plug from the outlet and request a repair to the purchasing place.
- Please do not disassemble the body and if there is a malfunction, user must be followed instruction of the maker.
- Please do not modify the product, it is not for our responsibility and it is beyond of the guarantee policy.

Caution

Please unplug the power plug from the outlet when it is not used for the safety.

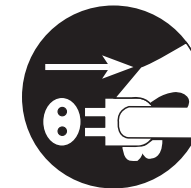

☒ Setting the machine

*Please avoid the place where there is covered by dust or corrosive gas is generated.

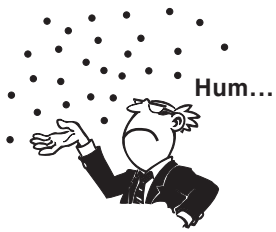

*Please avoid the place where there is a shock and vibration.

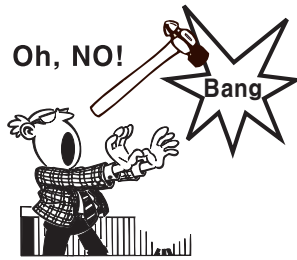

*Please place the product to a distance from the machinery generates noise.



●About the external sensor(Optional)

- Please do not bend the protecting tube.
- Please do not put it in the liquid to the lead.
- Please do not use this in the beyond of the temperature of spec.



Please put ground connection into right place firmly.
It may cause an electronic shock in case of the malfunction or electro leakage.
Please ask to electrical manufacturing company in case there is not a ground connection an outlet.



Caution The protection device may not be worked when the machinery do not used in specified ambient environment.

☒ Trouble Shooting

Problem	Check & Handling
It can not drive the timer.	<ul style="list-style-type: none"> • Please check the timer function is set well with setup mode. (The timer function does not work when the setting of the program function is ON.) • Please check Auto tuning function is OFF. • Please check the time setting is proper. (Min. setting unit is 1 min.)
It can not drive the program.	<ul style="list-style-type: none"> • Please check the program function with setup mode well. (The timer function does not work when the setting of the program function is ON.) • Please check Auto tuning function is OFF. • Please check each setting value of the program is proper.
It can not operate the Auto tuning.	<ul style="list-style-type: none"> • Please check the timer, program function is OFF with setup mode. • Please check the auto tuning function is ON with setup mode. • Please check it is in an examination state of others with this product performance.
It can not be agitated.	<ul style="list-style-type: none"> • Please check there is an alien material or dirt on an agitator. • Please check the outlet of the agitator is proper. (Except TMK-4K) • Please check Flow control panel are closed. • Please check it is proper liquid measure or liquid for the pump. • Please check there is no obstacle to agitator in the bath.
It can not be communicated well. (For TMK-3K)	<ul style="list-style-type: none"> • Please refer to [Trouble shooting] of the setting communication of [Communication soft operation guide] in an additional CD-ROM.

※If it can not be repaired with the above guide, please stop the using, unplug the power and contact to the purchasing agent.

☒ Trouble shooting

◎When it is regarded as a malfunction, please check the below contents before request the repair.

Problem	Check & Handling
Power supply does not working.	<ul style="list-style-type: none"> • Please check the blackout, breaker etc and the electricity is coming to the power outlet. • Please check the power plug is put into the outlet firmly. • Please check the power switch of the body is at ON.
The temperature indication does not working.	<ul style="list-style-type: none"> • Please check the problem with error code in case there is an error code indication. (Refer to the error indication of Function page.) (Notice)It is regarded as the malfunction of the inner electronic control circuit when [Err0], [Err1], [Err2] are indicated in LCD indication part. In this case, please stop the using, unplug the power plug and request to the purchasing agent.
The setting of temperature does not working.	<ul style="list-style-type: none"> • Please check the key is locked. • Please check the timer, program function is ON. • Please press Start/Stop button over 3 seconds. (As the press time is longer, it starts to check the setting temperature and drive.
The temperature control does not working.	<ul style="list-style-type: none"> • When the external sensor is used, please check the sensor position is set properly. (In case of using TMK-3K option sensor) • Please check the problem with error code in case there is an error code on LCD indication part. (Refer to the error indication of function page.) • Please check each setting value of the program is proper. • Please check there is machinery generates high frequency noise around the product. • The temperature control is set as a proportional operation (P operation) when the product is shipped from the factory. Please use the P, I, D value or auto tuning function is under the user's operation condition. • Please check it is in an examination state of other with this product performance. • Please check the any change of the liquid measure. • Please check the inner liquid measure of the bath and agitator status are proper. • Please check the ambient environment condition is proper. (Ex)The temperature difference is big.

☒ Name of the part

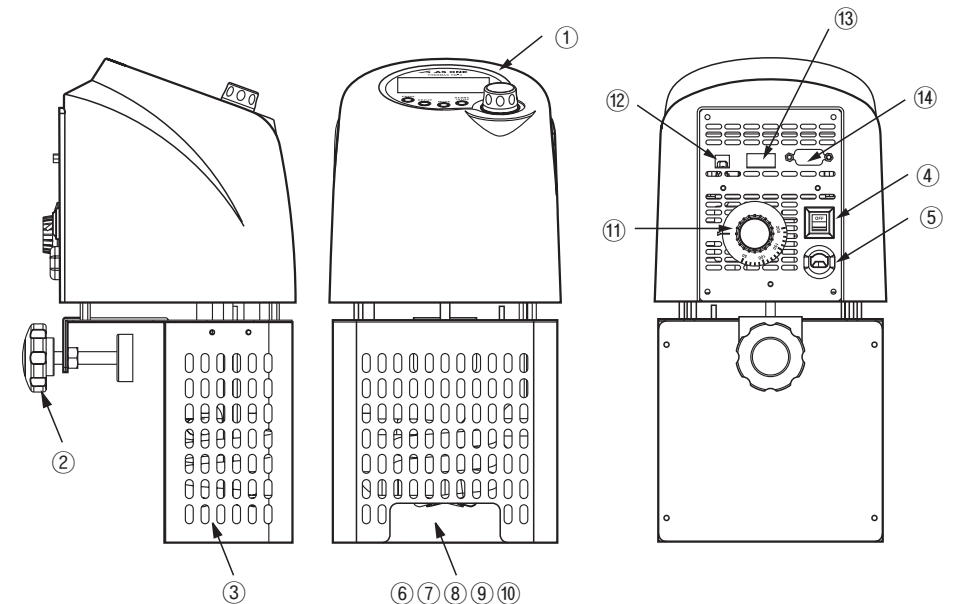

- ① Operation panel
- ② Fixed knob
- ③ Heater cover
- ④ Power switch
- ⑤ Power code
- ⑥ Heater
- ⑦ Agitator(*4)
- ⑧ Float switch(*1)
- ⑨ Temperature sensor
- ⑩ Inhibition sensor of the over temperature (*2)
- ⑪ Inhibition switch of the over temperature(*2)
- ⑫ Alarm output terminal(*3)
- ⑬ External input thermocouple terminal(*3)
- ⑭ RS232C communication port(*3)

(Operation panel)

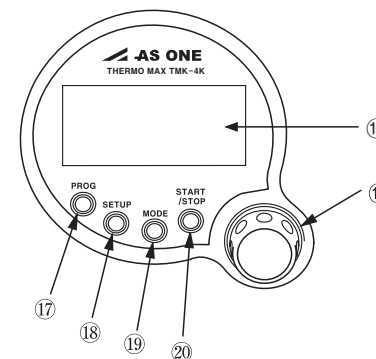

- ⑮ LCD Indication part
 - ⑯ JOG switch
 - ⑰ Program key(*1)
 - ⑱ Setup key
 - ⑲ Mode key
 - ⑳ Start / Stop Key
- (*1) It is not included in TMK-1K.
 (*2) It is not included in TMK-1K, TMK-2K.
 (*3) It is not included in TMK-1K, TMK-2K, TMK-4K.
 (*4) TMK-4K is a metal propeller.

Dimensions

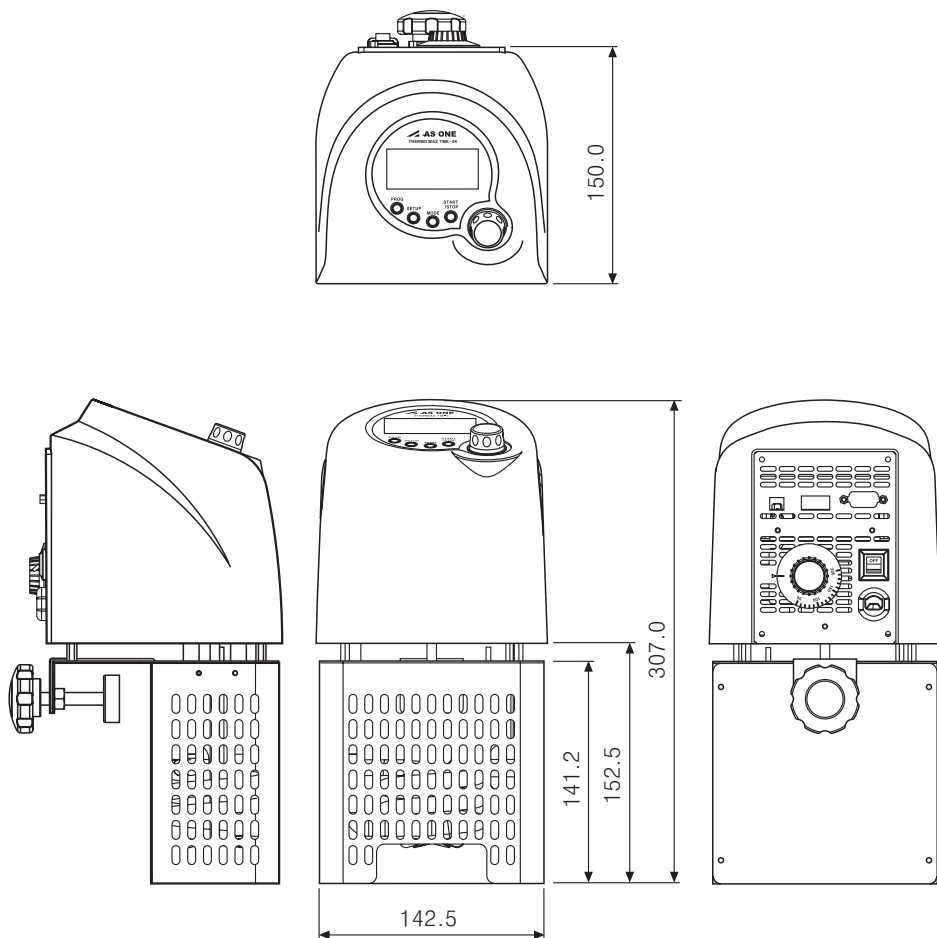

(This is a TMK-3K dimension.)

About the manual reset function

○The temperature control is set as a proportional operation (P operation) when the product is shipped from the factory. P operation is a control operation which output as much as in proportion to the input. P operation has a proportional band for Setting value (SV) and it called proportion operation, the manipulated variable (Control output variable) is proportion to deviation.

Manual-operated reset function offsets the proportional band for Setting value.

(Setting range of the proportional band, setting of the manual reset can be set by setup mode.)

(The manual reset function can be used when the proportional is operated only.)

○(Ex) Refer to the TMK-3K.

●Temperature range the proportion band in $-20\sim 80^{\circ}\text{C}$ is 3% of the product, the range will be about 3°C is converted by temperature.

When set the setting value as a 60°C , the output will be ON until 57°C , because the manual reset is 0% (Initial value) and if it is over 57°C , OFF cycle is generated, it will be OFF at 60°C .

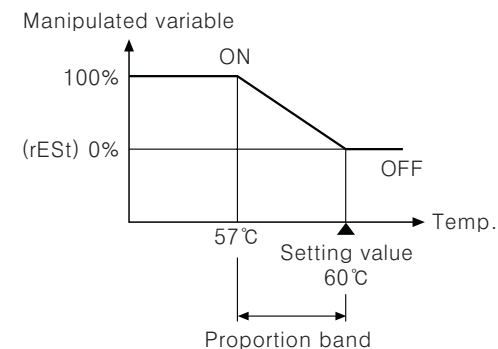

●Please refer to the below examples are set by 50%, 100% of reset from the above.

• Example of 50% with manual reset • Example of 100% with manual reset

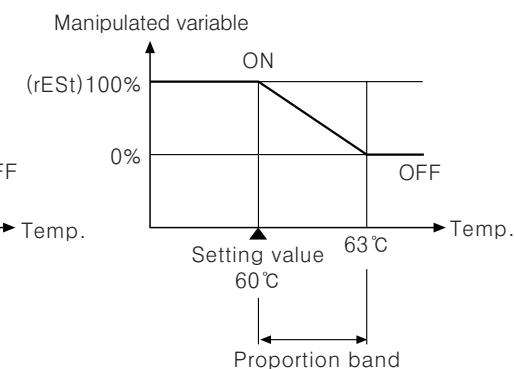
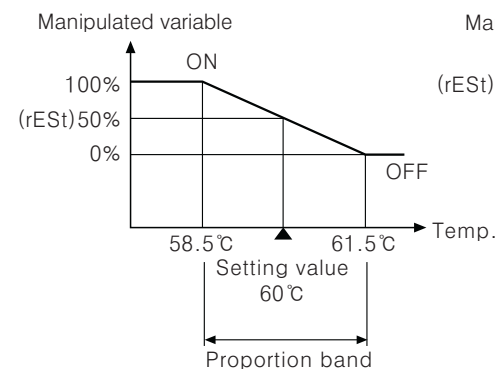

Key Lock function

- ◎The key lock can be set by pressing a setup key over 3sec.
After the key lock is set, setting the each mode and change can not be possible.

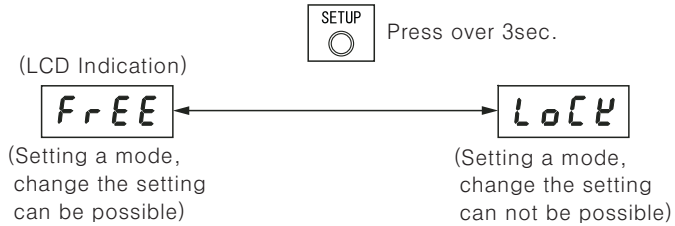

Setting the initialization

- ◎The data initialization can be set by pressing a mode key over 3sec.
(This method is used when total time indication(ot) set the initialization.)

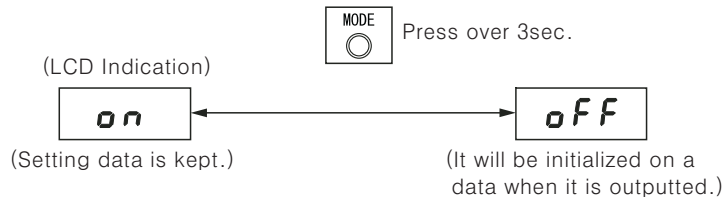

(Caution) The initialization setting is valid after the power to restart.

The initialization of shipment

SV	000.0	PrG (*2)	OFF	I	0	rEst	000.0
ALM (*1)	OFF	At	OFF	D	0	rEC (*1)	ON
Ad	000.0	BUZ	ON	t	2.0		
Stt	OFF	P	3.0	HyS	000.0		

(*1) It is a function for TMK-3K only.

(*2) There is no this function in TMK-1K.

Specifications

Name	TMK-1K	TMK-2K	TMK-3K	TMK-4K
Power supply	220VAC 50/60Hz(90 ~ 110% of the power supply)			
Current consumption	Max. 1100VA			Max. 1350VA
Heater capacity	Approx. 1KW			Approx. 1.2KW
Indication method	LCD Digital indication			
Input	Inner	Thermocouple K(CA)		
	External	_____	Thermocouple K(CA)	_____
Stirrers	A classification type(Include marker type flow regulating function.)			Propeller type
Set range of temperature	-20.0 ~ 80.0℃			-20~180℃
Temperature range of setting the usage	Room temperature +5 ~ 80℃			Room temperature +5~180℃
Control method	ON/OFF control, PID control			
Operation method	Setting by front push buttons and JOG dial switch			
Safety device	Self-diagnosis function(Detection of the abnormal of upper & lower temperature, Detection of the abnormal of the sensor), Circuit protect			
	_____	Detection of level with Float type, Buzzer alarm		
	Inhibition device of the abnormal heating(Thermostat)	Inhibition device of the variable over temperature		
Indication degree	±3℃			
Capacity of pump	Max. discharge:10 liters/min Max. head of fluid:1.4m			_____
Additional function	Program function			
	_____	RS232C communication function Alarm output (Relay contact capacity:12VDC Max. 50mA)		_____
Dimensions	142.5×150×307(Except the projection)			
Available width of handling the clamp	Approx. 40mm			
Ambient temperature	5 ~ 35℃			
Storage temperature	-10 ~ 50℃ (at non-freezing status)			
Ambient humidity	35 ~ 85%RH			
Accessories	Bath(Heatproof ABS)/ Dimension of bath:194×336×156mm			_____
	_____	Communication soft(CD-ROM)		
Weight	3kg		3.2kg	

✕ LCD Indication part

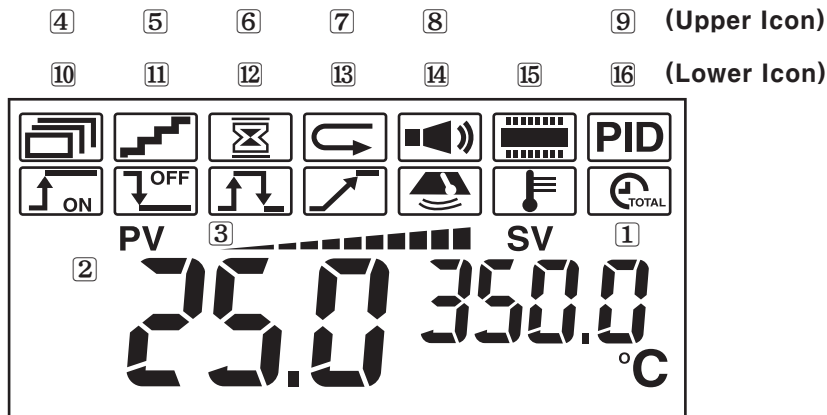

- ① Setting value (Indicate the setting value. It can be possible to change the temperature setting when it is flashing.)
- ② Measure value (Indicate the measured temperature.)
- ③ Output indication (Indicate output control state when control output is committed.)
- ④ Setting the program mode (Indicate when it is in the program mode.) (*1)
- ⑤ Program mode—Setting the step (StP)
(Indicate when set more 2 steps at program mode.)
- ⑥ Program mode—Setting the wait (Wt)
(Indicate when set the wait time at program mode.)
- ⑦ Program mode—Setting the repeat (rEP)
(Indicate when set the program repetition of program mode.)
- ⑧ Setting the sound of Key input / Alarm ON / OFF
(Indicate when set the alarm as ON.) (*2)
- ⑨ PID control indication (Indicate when control the PID.
It will be flickered when the auto tuning is committed.)
- ⑩ Setting the ON timer (Indicate when set the ON timer.)
- ⑪ Setting the OFF timer (Indicate when set the OFF timer.)
- ⑫ Setting the ON/OFF timer (Indicate when set the ON/OFF timer.)
- ⑬ Setting the Wait timer (Indicate when set the wait timer.)
- ⑭ Setting the Upper / Lower temperature
(Indicate when upper/lower temperature setting function is at ON.)
- ⑮ Setting the indication temperature correction function
(Indicate when the indication temperature correction is committed.)
- ⑯ Setting the indication total operating time

(*1) It is not indicated on TMK-1K.

✕ Using method of Auto tuning

- It is possible to control the high accuracy of temperature.
(Please set the timer, program function as OFF when auto tuning is installed.)
(There is no auto tuning function in timer, program mode.)
- Please set the auto tuning function as a setup mode.

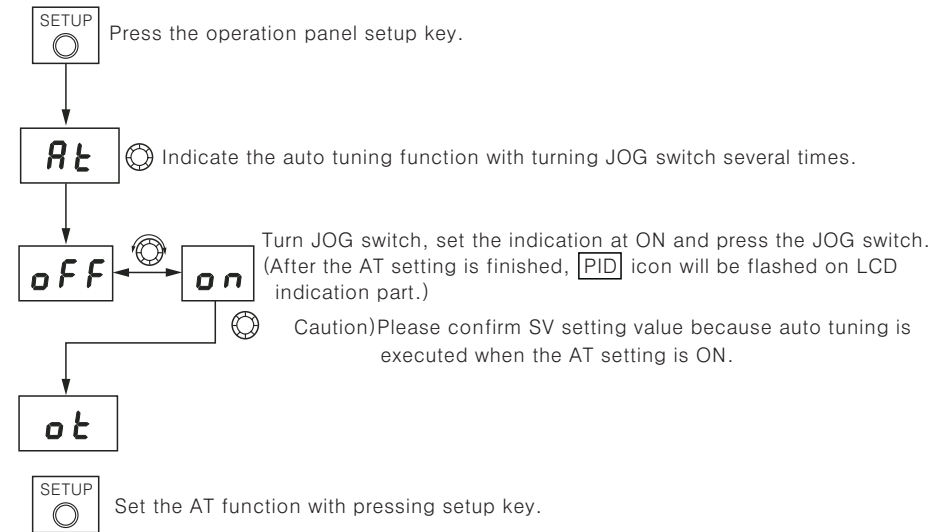

- Set the temperature with turning JOG switch.
- Start the auto tuning with pressing JOG switch over 3sec.
(SV will be lighted and PID icon is flashing.)
- PID icon will be lighted when auto tuning is finished.
(It will be served as a good reference for another setting PID when check PID value by setup mode and record the value when control the temperature with auto tuning.)

Setting method of program mode

- In case of setting programs, please set the program function setting as ON with setup mode. (The program mode setting is impossible when the program function setting is OFF)
- Please press the operation panel program key in order to set the program. (Please set the program after stopping the operation. It is not possible to set the program during the operation.)
- Please refer to [Program function] (P12) for the details of program function.

• Example of setting

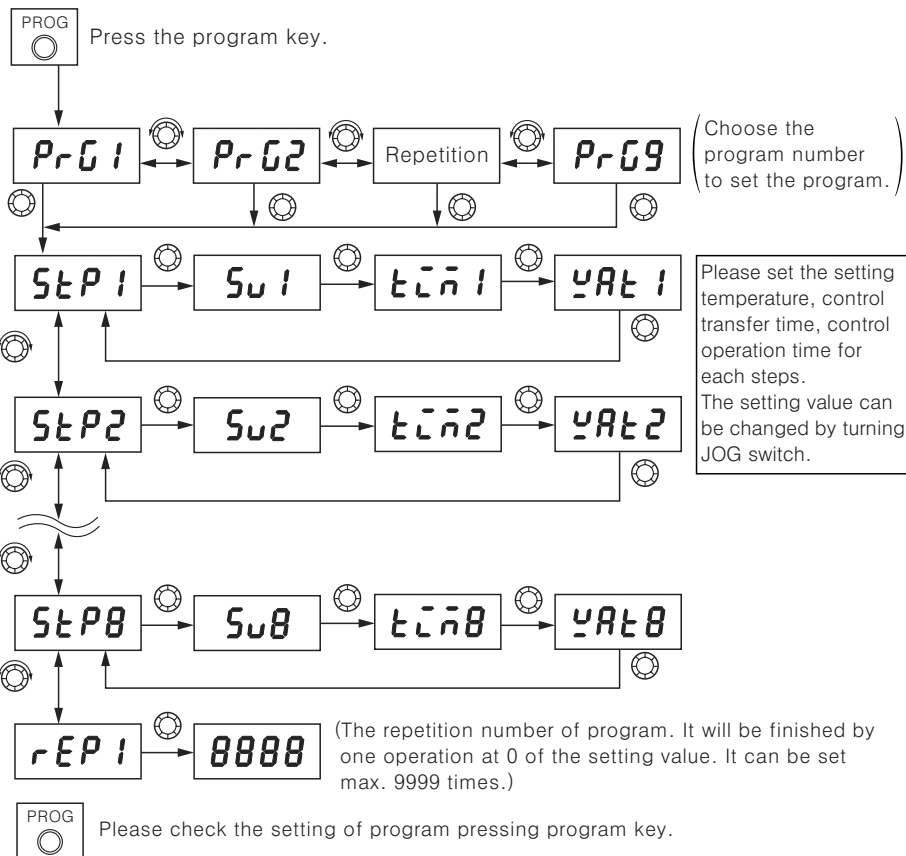

Using method

Before using

1. Please check the product power code, control machinery power code is set firmly.
2. Please install the software when the communication soft is used. (Please refer to the [Communication soft operation guide] in an additional CD-ROM for the method of installation of communication soft, setting method etc.) (In case of using the option function of TMK-3K)

! Please put ground connection into right place firmly.

⚡ It may cause an electronic shock in case of the malfunction or electro leakage.

⚡ Please ask to electrical manufacturing company in case there is not a ground connection in outlet.

3. This product works well in rated power supply, frequency.
4. Please set the product in firm and flat place.
5. Do not set the product if there is machinery generates high frequency noise around.
6. Do not set in place there is flammable, corrosive gas or materials.
7. Please take an enough space for an easy test.
8. Please clean dirt, alien materials in inner bath for a pump.
9. Please be careful to the air cell. (The TMK-1K is no prohibition device for air cell, please check the level of the inner bath before or during the operation and the heater is in the liquid.)
10. Do not use the liquid can corrode and deteriorate the product.
11. Do not use the flammable liquid, it may cause the fire. **⊘**

⚠ Caution The protection device may not be working when the machinery do not used in specified ambient environment.

Order of the operation

Preparation of the bath

- For TMK-1K, TMK-2K, TMK-3K

Do not use the liquid can corrode and deteriorate the inner part of the bath, in case of using the bath. And prepare a separate inflammable bath can endure the using temperature, when the bath is not used. (Min. 80°C)

- For TMK-4K

There is no belonging bath. Please prepare a separate inflammable bath can endure below 180°C of the using temperature. Please make the measure of the belonging bath as a standard of TMK-1K, TMK-2K, TMK-3K. Please use service water, silicon oil with above 300°C of the flashing point, under 100cst of viscosity.

When service water is using, please use it at the temperature before the liquid is not boiling. Do not use the liquid can damage connection part such as a heater.

(The quality of the connection liquid section is SUS304.)

(Caution) Please choose the bath carefully because its performance can not be worked fully differentiate by difference of shape, capacity, adiabatic performance.

Danger Do not use the flammable liquid, it may cause the serious accident.

Mounting of the body

- Please decide the position, fasten the fixed knob on the bath.
(Do not fasten the fixed knob too strong. It may break the fixed knob and bath.)
- The direction of the agitator can be changed. It is possible to change agitator state or flux by controlling the mouth of the suction part. (Except TMK-4K)

Liquid sufficiency of the bath

- Please pour the liquid into the bath slowly.
Please do not pour the liquid on the operation panel part.
- Please adjust the level of the surface with using state.
(Please check the heater coil part is in the liquid after the agitate.)
(Refer)The standard of the liquid surface is 20mm under from the top of the heater cover. (In case using the belonging bath)
(Please set the liquid level with using state.)

(Caution)

- The position of the surface can be change by evaporation, changing of the liquid temperature during the operation, please be careful about it.
- If the liquid with a bad quality is used, insoluble materials stick to the heater or agitator and it may cause malfunction. In this case, handle the liquid first.

Check the power

- Please put to earth (-) or it may cause the electric shock.
- Please check the power switch is at OFF.
- Please check the power code is set firmly.
- Please use the rated power, supply and frequency.

Setting the timer mode

- In case of setting the timer, please set the timer function by setup mode before the operation.

(If the setting of the timer function is not set, the timer setting can not be set.)

- Please press the operation panel mode key to set the timer.
(Please set the timer after stopping the operation. The timer setting can not be set during the operation.)
- Please refer to [Timer function](P 14) for the details of the timer function.

- In case the Stt is set as t-1 with t--1(ON time set ) setup mode

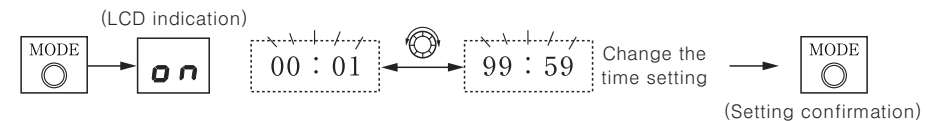

- In case the Stt is set as t-2 with t--2(OFF time set ) setup mode

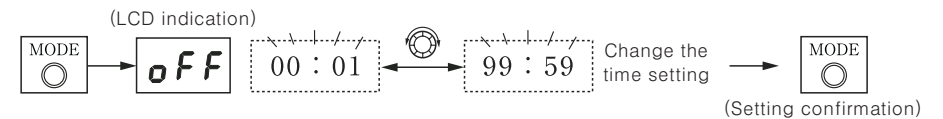

- In case the Stt is set as t-3 with t--3(OFF time set ) setup mode

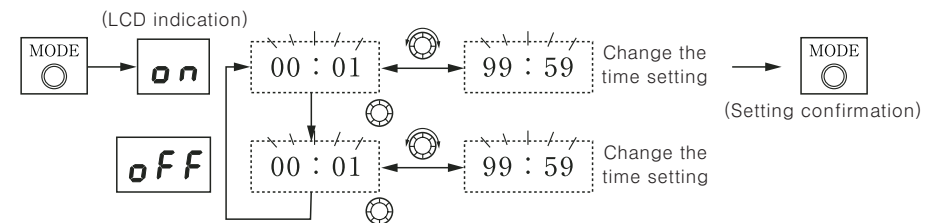

- In case the Stt is set as t-4 with t--4(Wait time set ) setup mode

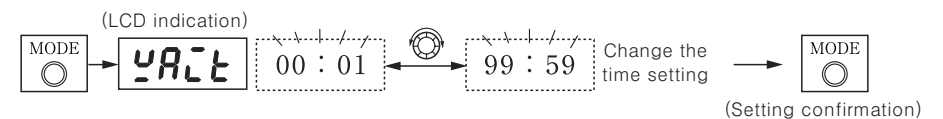

- When the setting of timer is confirmed, press JOG switch over 3sec and start the operation. (Remaining time is indicated LCD indication setting value during the operation.)

Parameter input method of setup mode

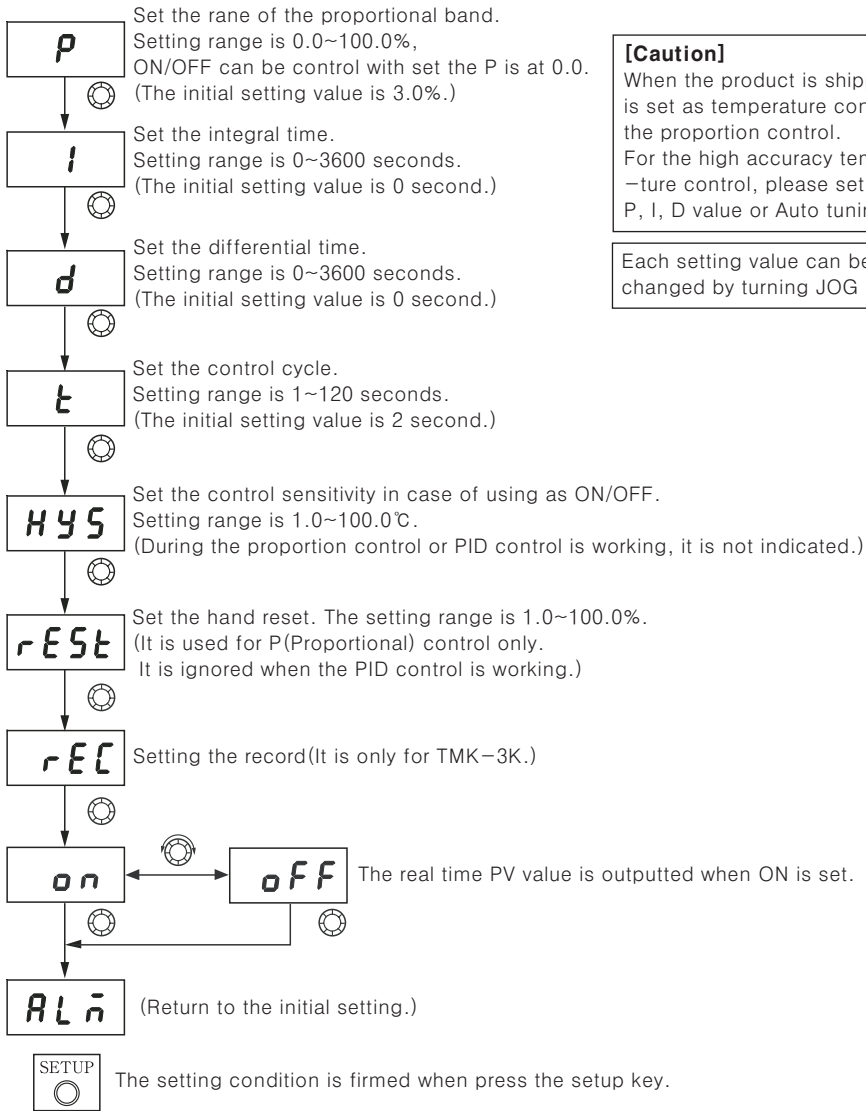

[Caution]
When the product is shipped, it is set as temperature control at the proportion control.
For the high accuracy tempera-
-ture control, please set the P, I, D value or Auto tuning.

Each setting value can be changed by turning JOG switch.

[Caution]
Press JOG switch when change the setting and press the setup key in order to firm the change.

Order of the operation

Order of the operation

Please turn the power switch ON in the side of the body. (Adjust the inner control circuit for seconds.) After PV and SV are indicated (Flashing state) on LCD indication part, it is the wait condition of operation.

The agitator starts to work the moment power is inputted.

(Caution) In case of using TMK-3K, TMK-4K, after set proper temperature of prohibit rising of the prohibit the variable temperature rising switch before input the power and press RESET button (Red button) to handle it. (If it is reset, there is a sound of the machinery.) If it is not reset, it may not be controlled the temperature.

Change the setting value

The setting value can be changed by turning JOG switch at the operation wait condition (Flashing state of setting value).

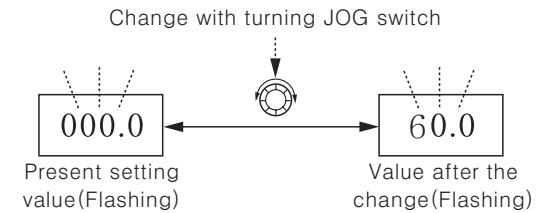

RUN

After confirm the setting value, press JOG switch over 3 seconds. It starts to control temperature changing the setting value into light on status.



Stop

In case of stopping the operation or changing the setting value, press JOG switch to stop the operation. The setting value is flashed when the operation is stopped.

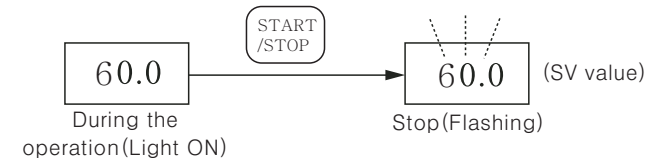

Function

◎Sensor switching function(It is only for TMK-3K.)

This product can control the temperature with standard of inner and external temperature sensor(option).

- In a standard state, it is controlled by standard temperature sensor of the inner water bath.
- When the external temperature(option) is used, please connect it during the operation of the inner temperature sensor.
- In case of connecting the external temperature sensor(option), the temperature control is committed by the external temperature sensor. (It can not controlled by the inner temperature sensor.)
- In case of taking off the external temperature sensor, the inner temperature sensor controls the temperature.
- The inner/external temperature sensor can not be used at the same time.

In case of using at the same time, the external temperature sensor controls the temperature.

◎Program function(No.1~No.9) (It is only for TMK-2K, 3K, 4K.)

This product has a program function.

- Max. 8 step of the temperature control condition can be set in one program.
- Each step has target temperature correction value, control temperature transfer time, temperature control operation time.
- It is possible to set from min. 2 step to max. 8 step in one program.
- When the program is installed, it is controlled by set target value, time of each step.
- It can be composed max. 9 program.

(Caution)

- It can not be possible to install plural programs at the same time and install another program continuously.
- When input '0' at the control temperature transfer time, there is no progress of steps any further. (The input data after the step is inputted 0 at t-* will be ignored.)
- It will be possible to get to the setting temperature in the control temperature transfer time or not.

(Ex. Reference of the setting)

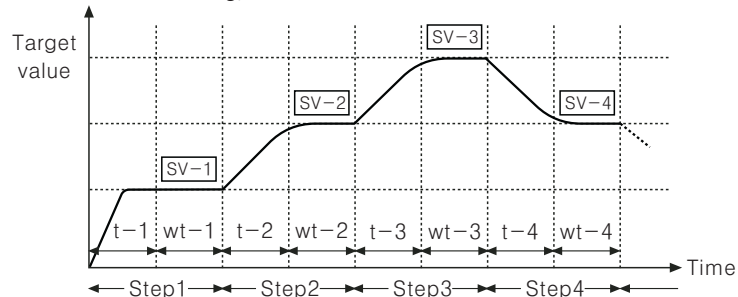

(Step is finished at t-5=0)

Parameter input method of setup mode

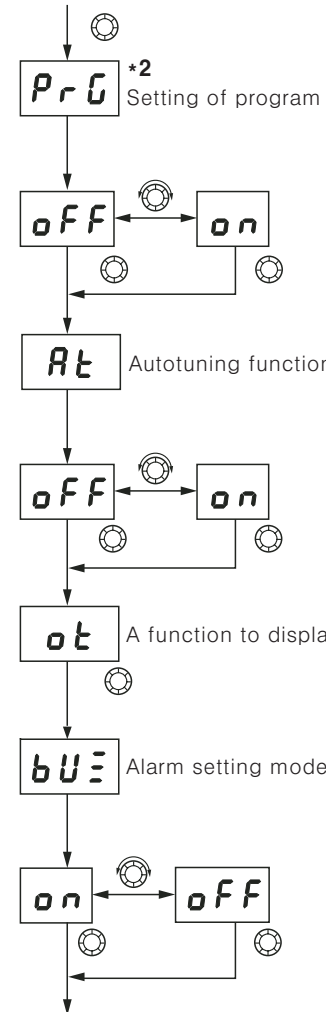

[Caution] It can not be set when the setting of timer function is ON. In case of setting the program function, please off the timer function.
 (*2)TMK-1K does not have the program function.

[Caution]
 1. Auto tuning function can not be used when one of the timer, program function is at ON. In case of using the auto tuning function, timer, program function must be at OFF.
 2. Auto tuning function can not be used when P is set as 0.0. In case of using the auto tuning function, proportional band range must be set over 0.1.

In case of setting ON, each mode and finishing the program function, it buzzes.
[Caution] The buzzer for alarm of upper, lower temperature does not work. (For TMK-3K)
 (*1) It is only for TMK-3K.

Parameter input method of setup mode

- Input the parameter with setup mode in a stopping state.
(During the operation, it can not be changed the parameter input.)
- Press the operation panel setup key in order to input the parameter of setup mode.

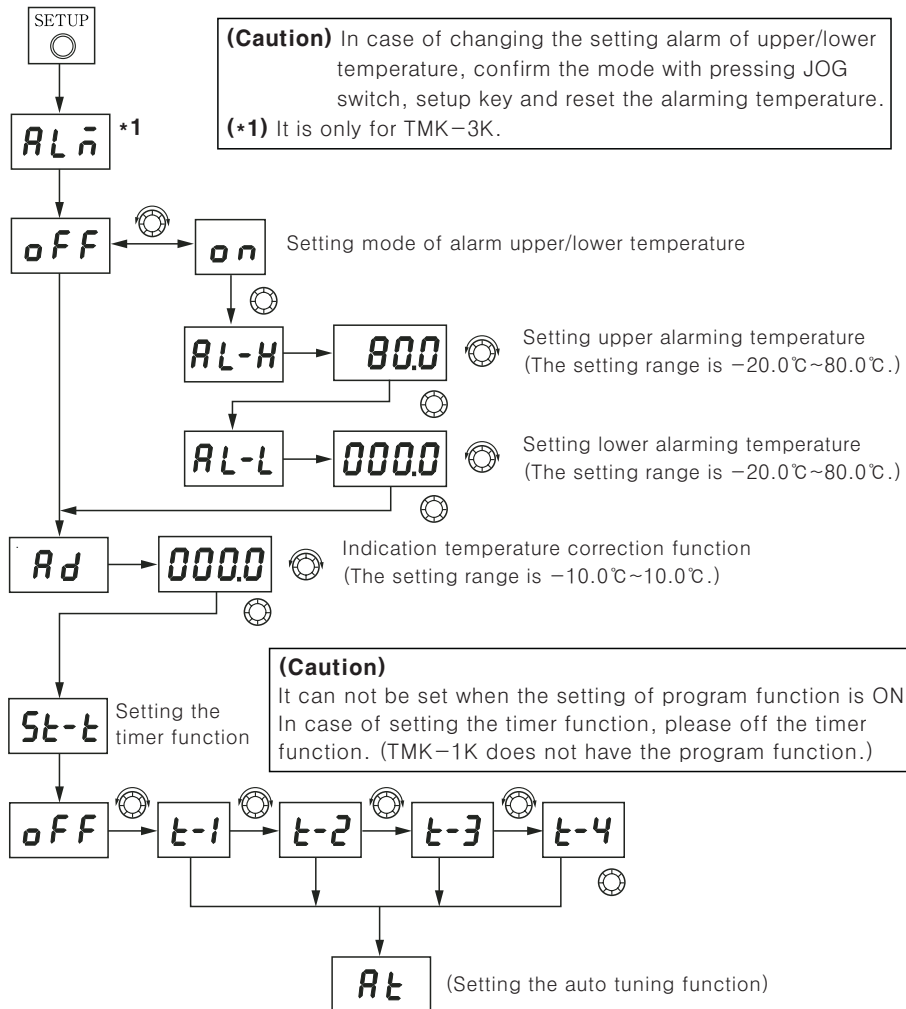

Function

Step	Step1	Step2	Step3	Step4	Step5	Step6	Step7	Step8
No. 1	SV-1	SV-2	SV-3	SV-4	SV-5	SV-6	SV-7	SV-8
	t-1	t-2	t-3	t-4	t-5	t-6	t-7	t-8
	Wt-1	Wt-2	Wt-3	Wt-4	Wt-5	Wt-6	Wt-7	Wt-8
No. 2	SV-1	SV-2	SV-3	SV-4	SV-5	SV-6	SV-7	SV-8
	t-1	t-2	t-3	t-4	t-5	t-6	t-7	t-8
	Wt-1	Wt-2	Wt-3	Wt-4	Wt-5	Wt-6	Wt-7	Wt-8

- It is possible to set the setting time by 1 min from 1 min ~ 99 h 59m[00(H):00(M)] of each step.
- The repetition number of program can be set 9999 unit of times.
(It will be finished by one operation at 0 of the setting value.)

Function of upper/lower temperature alarm (It is only for TMK-3K.)

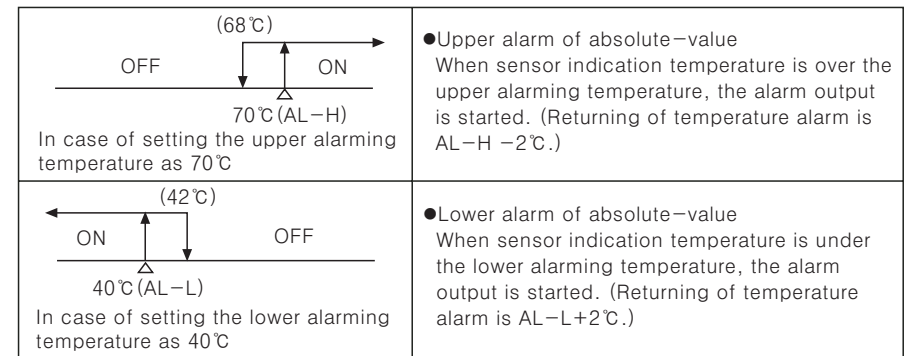

*Returning of upper/lower temperature alarm (Hysteresis) is fixed 2°C.

Indication function of operation time

Indicate the operation time. It is indicated by an hour.

Alarming sound function

There is a buzzer in it. It will be buzzed for setting the each mode when set the buzzer as ON with setup mode.

Function of inhibition the over temperature (It is only for TMK-3K, TMK-4K.)

The inhibition of over temperature can be controlled by the inhibition of over temperature switch is on a side of the body. When it is over the set temperature, the inhibition function of the over temperature starts to work, applying an electric current of the heater is off. (The agitation is keep working.) Even if the liquid temperature is lower than the setting temperature, it does not apply an electric current. (It does not self-return.) In case of driving again, make the power off and press the RESET button (Red button) of the inhibition of over temperature switch, input the power switch again.

(Caution) The temperature setting scale of the inhibition of over temperature switch has small amount of temperature setting range for operation temperature. If a high accuracy of the inhibition of over temperature is needed, request it separately.

Function

○Detection of sensor abnormality

When the abnormality is detected, error is indicated on LCD indication part. (Error message)

- Flashing of "Open" : in case input sensor is disconnected or sensor is not connected
- Flashing of "HHHH" : in case measured sensor input temperature is over the range of the temperature setting
- Flashing "LLLL" : in case measured sensor input temperature is under of the range of the temperature setting

○Timer function

It is a function of setting the control output start, progress and completion time.

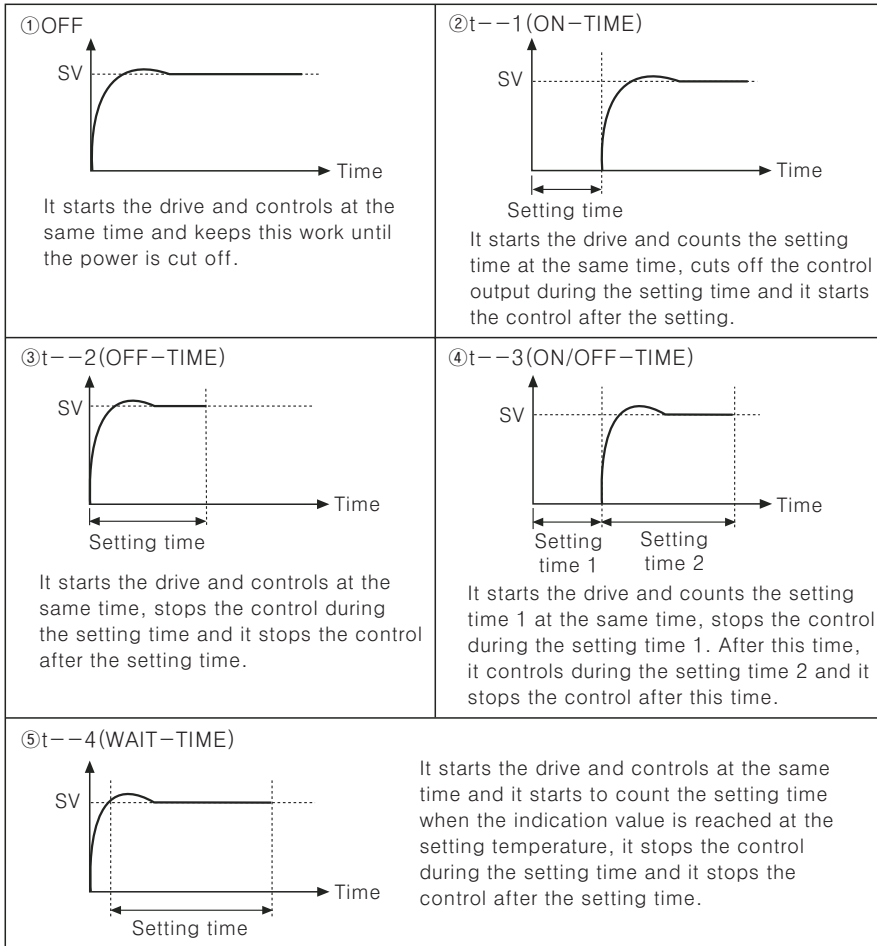

*Setting time : It can be set by 1 min within 99h59m.

Setting the parameter

※ indicates the turning of JOG switch, ○ indicates the pressing of JOG switch.

(Caution) (*1) It is only for TMK-3K. It is not indicated in other series.

(*2) It is only for TMK-2K, 3K, 4K. It is not indicated in TMK-1K.

